

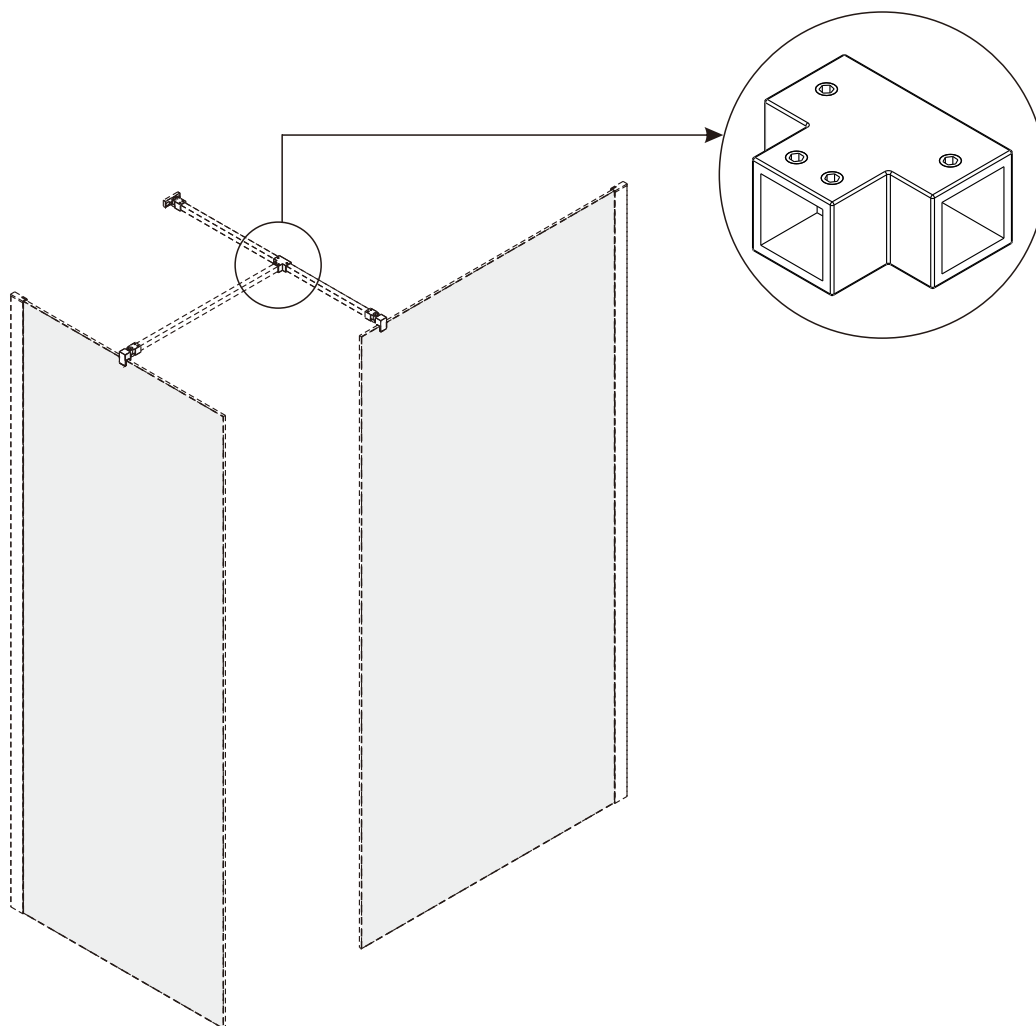

Thank you for choosing Better Bathrooms.
Please read this manual before installing your product
and keep for future reference.

better 
bathrooms

T - Shape Bracket Matt Black BeBa_28558



- Multi or Single-person assembly
- Tools required
- We always recommend using professional tradespeople to install your product

Congratulations on your purchase

And welcome to our growing gang of savvy shoppers

We're on a mission to bring you extraordinary bathroom products, for less. From modern to traditional style ceramics, plus the gorgeous fixtures, fittings and furniture to match. So, you can fall in love with your space every single day.

As one of the UK's largest independent bathroom stores, we've received countless awards; including the National Business Awards UK, the Digital Entrepreneur Awards and being placed on The Sunday Times Fast Track 100.

We hope your new product goes above and beyond your expectations. However, should any problems occur, please:

- log in to your account and contact our customer services team via your self-serve portal – betterbathrooms.com/CustomerAccount/Login
- contact us via betterbathrooms.com/content/contact-us

Important information

- Please read these instructions thoroughly and retain for future reference
- Always check for pipes and cables before drilling

CAUTION

- To prevent leaks, silicone must be applied on the outside of the shower and not on the inside
- Read all instruction carefully before starting the installation
- Save this manual for future reference

Contents

- PREPARATION & TOOL REQUIRED-----	PAGE 04
- CONTINUE-----	PAGE 05

Preparation

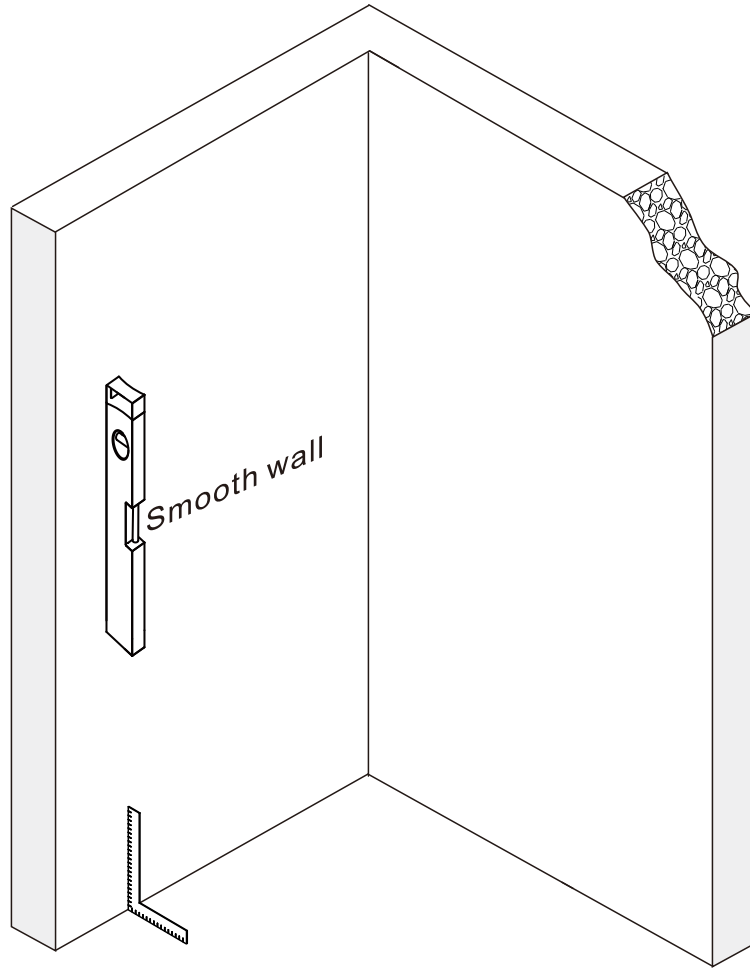

Tools required

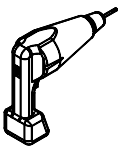

DRILL

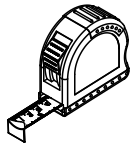

MEASURING TAPE



SILICONE



PRECISION KNIFE

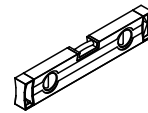

LEVEL

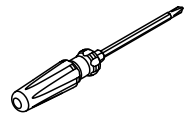

SCREWDR

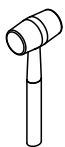

MALLET



SET SQUARE



PENCIL



DRILL BITS: 1/8", 3/16" ET 1/4"
*MASONRY DRILL BIT



SCREWS

A 01

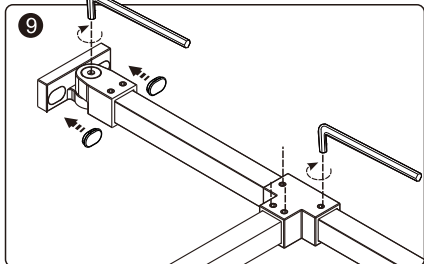
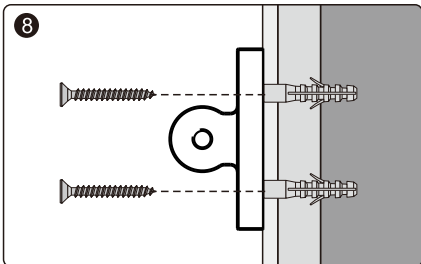
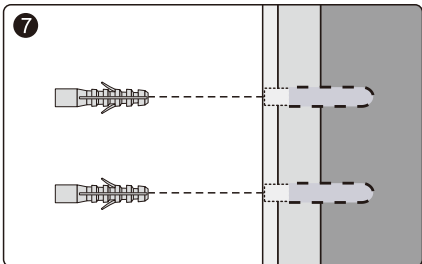
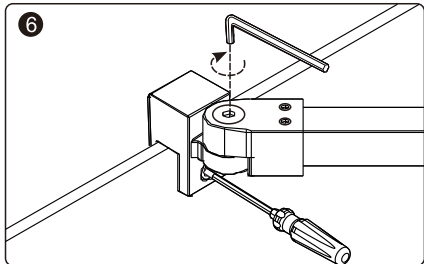
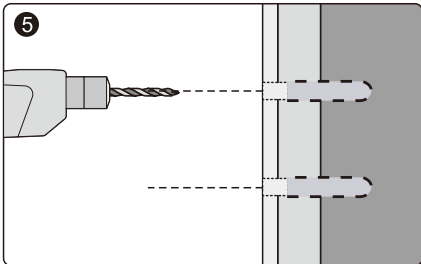
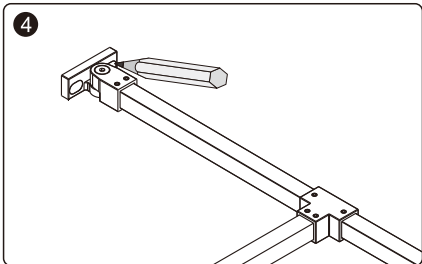
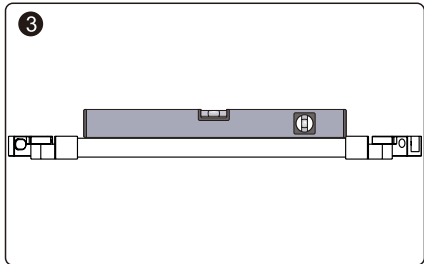
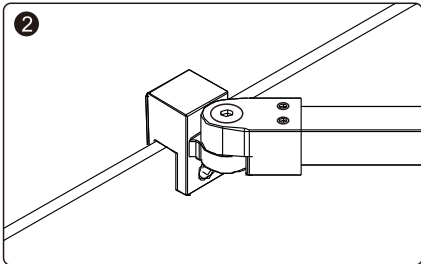
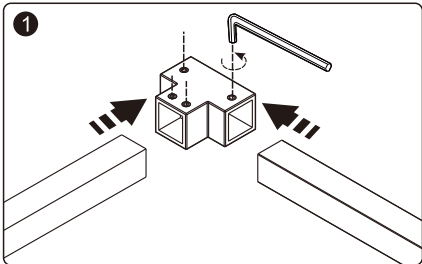
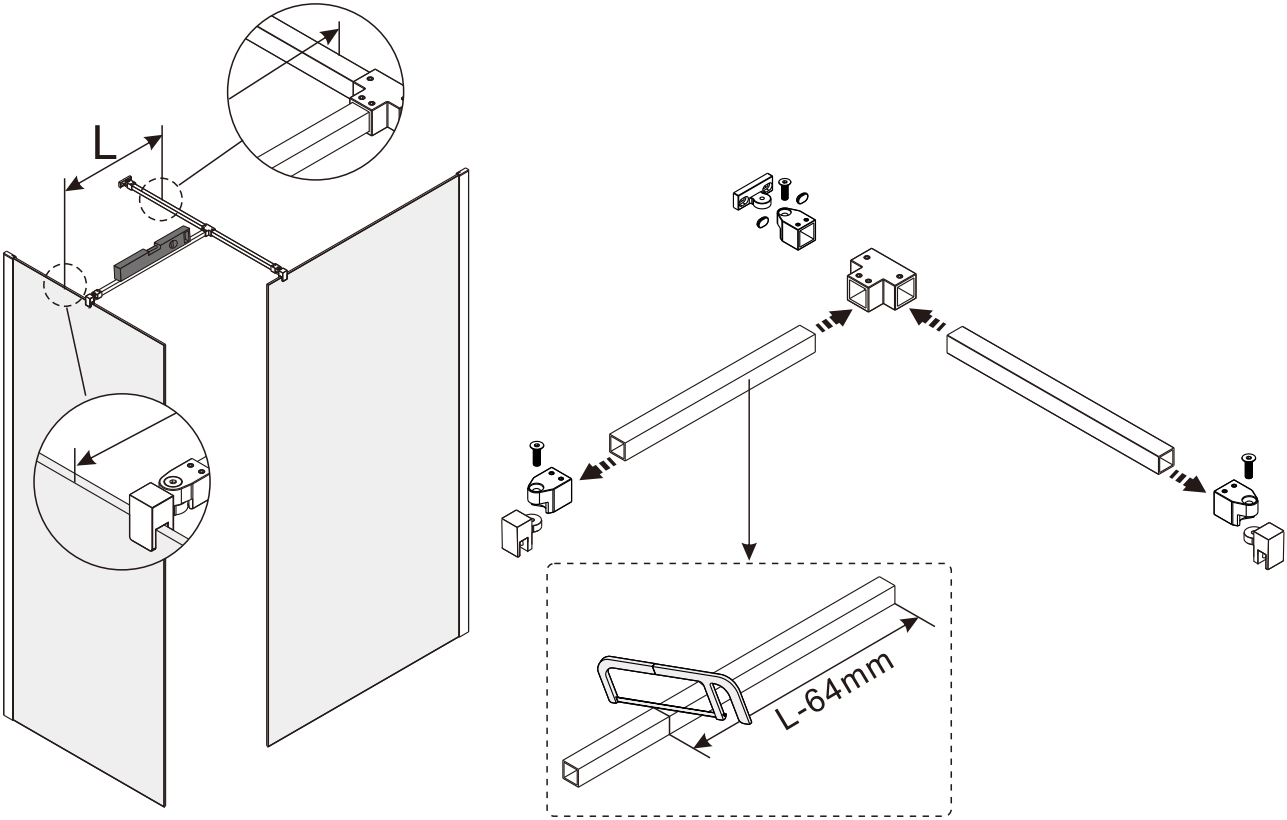

Maintenance & Cleaning

Use a PH-neutral cleaning agent to maintain and clean the surface of your product. Not to use alkaline, solvent, acid and chloric or scrubbing agents.

To maintain the surface of your product, wipe with a clean damp cloth and wipe dry, do not use any abrasive cleaning agents or materials. If any harsh chemicals come into contact with the surface of the product, rinse and wipe clean immediately.

For more information

- visit betterbathrooms.com
- email customerservices@buyitdirect.co.uk
- call 03303903062
- write to Trident Business Park, Neptune Way, Huddersfield, HD2 1UA

**better
bathrooms** 

Part of the BuyItDirect Group